

CUSTOMER TERMINAL	ROHS	Lead (Pb) -free
	YES	YES

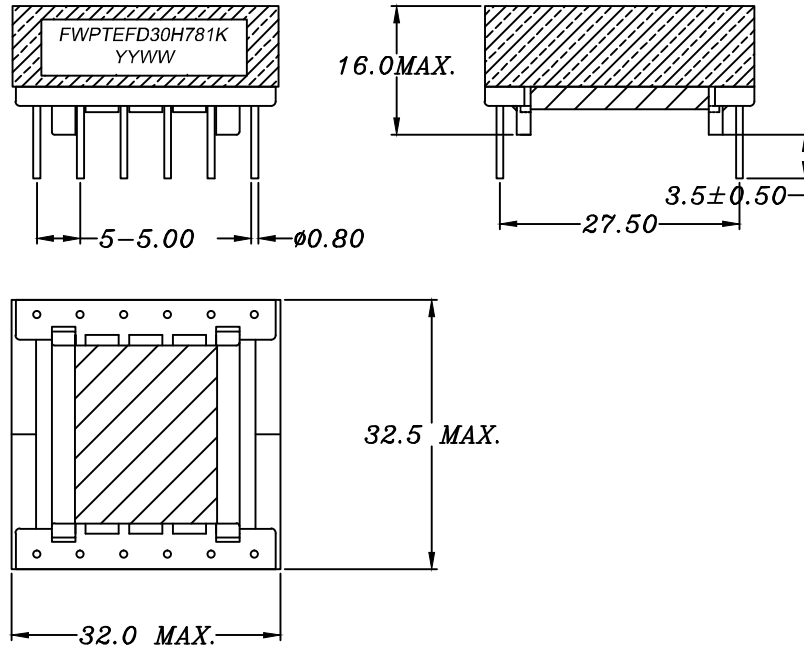

1. Mechanical Dimensions



2. Schematic Diagram

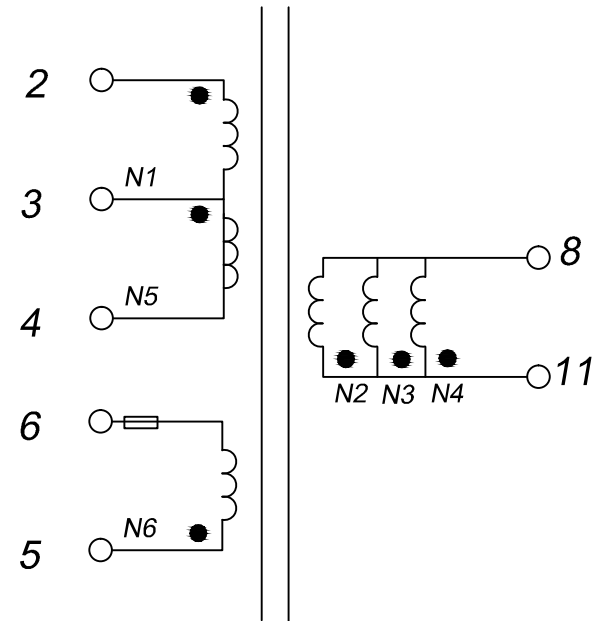

3. Material List

Core:FW44-EFD30/30/9
 Bobbin:FWB3003
 Wire:2UEW-0.2mm/0.25mm/0.40mm 130°C
 Tube:TFL TUBE
 Operating Temperature: -30 to 115°C

4. Electrical Specification

Inductance: L (2-4) =780uH±10% 1KHZ 1V
 LK (2-4) =6.0uH MAX 100KHZ 1V
 HI-POT: P-S AC 3000V 2mA 3S
 P、S-CORE 1000V 2mA 3S

REV.	DATE	 Convention Placement	DRW.	Drawing Title: TRANSFORMER	Part No:
0	00/00		CHK.		Customer P/N:
RoHS		www.ferriwo.com	APP.		Specification Sheet 1 of 1